

bticino

IDROBOX PLUS



CATALOGUE 08

Protected from water
and weather

ID08PC/GB

IDROBOX PLUS

IP55 controls and housings without transparent sheath

■ ALL PROBLEMS OF THE SHEATH BREAKING, AND OF DIRT, HAVE BEEN ELIMINATED

■ MAXIMUM LONG TERM RESISTANCE TO WEATHER CONDITIONS

■ IMPROVED ERGONOMIC DESIGN: DIRECT CONTROL OPERATION



2 Versions: Two-way Switch and Pushbutton



Housing (2 MATIX modules)



Two-way Switch and 2 MATIX module Housing



Nameplate pushbutton for 503E (available in LIVING, LIGHT, LIGHT TECH aesthetic)



IDROBOX PLUS

IP66 enclosure: protection with plug connected



■ IT ASSURES THE IP66 PROTECTION WITH ALL TYPES OF PLUGS:

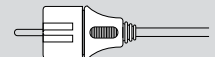

Straight plugs

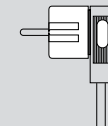

90° plugs

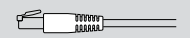

RJ connector



IP66 enclosure



■ The **IP66 container** is suitable for installation on TIPLUG switchboards, thus resolving the problem of the switchboard protection downgrading when devices with civil plugs are used.

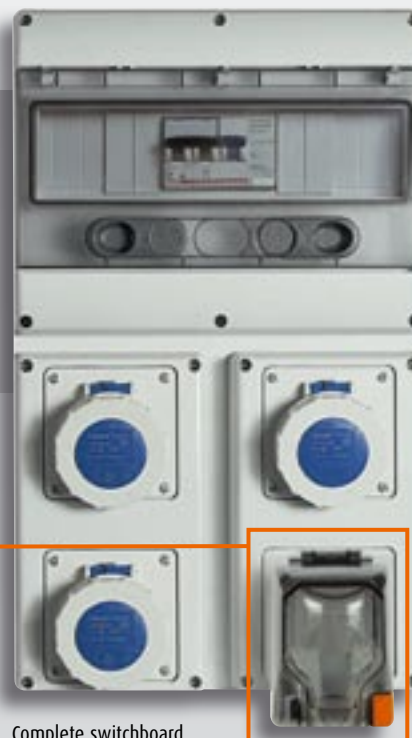

Complete switchboard

IDROBOX PLUS

IP55 controls and housings without transparent sheath

For installations in the home.

EXAMPLES OF INSTALLATION LOCATIONS

- GATE:
- pushbutton



- OFF-DOOR:
- nameplate pushbutton



- CELLAR AND BOX COMMON AREAS:
- 2 module housing for MÀTIX sockets
- two-way switch or pushbutton



- BOX AND CELLAR:
- enclosure with: two-way switch + 2 module housing for MÀTIX sockets





IDROBOX PLUS

IP66 protection with plug connected

EXAMPLES OF INSTALLATION LOCATIONS

- RESIDENTIAL :
 - outdoor:



- INDUSTRIAL/SERVICE SECTOR:
 - single load power supply
 - mounting on **TIPLUG** switchboard



- BUILDING SITE:
 - mounting on **TIPLUG** ASC switchboard



IDROBOX PLUS Installation solutions

IP55 SOLUTIONS

**IP55 pushbutton,
two-way switch:**
Complete and ready to
use configurations



**IP55 nameplate
pushbutton:**
Suitable for 503E,
502E, 502



IP55 housing:
Enclosure must be completed
with MÀTIX devices

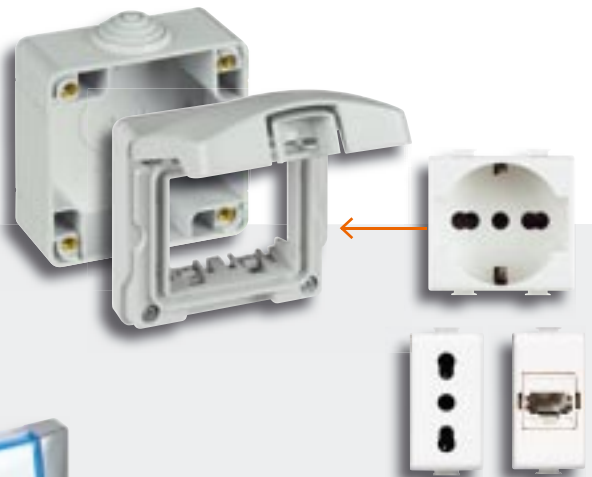

IP66 SOLUTIONS

- The container must be completed using MÀTIX devices

- IP66 protection is guaranteed with only one output cable

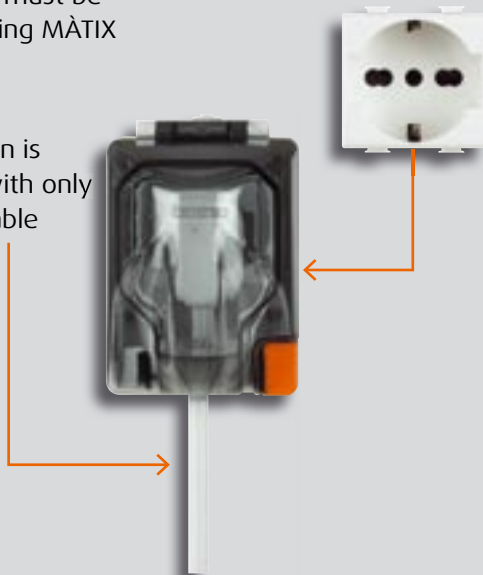

- Two versions:
Item 26066 wall-mounting
Item CQ26066 to be installed on TIPLUG switchboards



Wall-mounting
version

Version for TIPLUG
switchboards



IDROBOX PLUS Catalogue



IP55 ITEMS

Item	Description
26003	wall-mounting two-way switch 16A 250 V a.c. with axial movement, backlit with LED item H4743B/230 (to be purchased separately)
26005	wall-mounting pushbutton 10A 250 V a.c. with axial movement, backlit with LED item H4743B/230 (to be purchased separately)
26055	wall-mounting housing for MATIX devices - capacity 2 modules - IP55 is guaranteed when the door is closed
26200	monobloc wall-mounting 2 module enclosure, fitted with two-way switch and IP55 housing - Can be installed both horizontally and vertically. Two-way switch: 16A 250 V a.c. with axial movement, backlit with LED item H4743B/230 (to be purchased separately). Housing: for MATIX devices - capacity 2 modules.
26108L	nameplate pushbutton 10A 250 V a.c. backlit with LED technology (already installed) - can be installed on 503E, 502E, 502 flush-mounting boxes - 3 finishes: LIVING (item 26108L), LIGHT (item 26108N), LIGHT TECH (item 26108T)
26108N	
26108T	

NOTE: IDROBOX - PLUS items are compatible with IDROBOX accessories

IP66 ENCLOSURES

Item	Description
26066	enclosure for MATIX sockets (German standard, 2-centre, RJ) - capacity 2 modules. Guaranteed protection degree: IP66, with the plug connected and the lid closed - for wall-mounting installation
CQ26066	As above - for installation on TIPLUG switchboards

Dimensional data

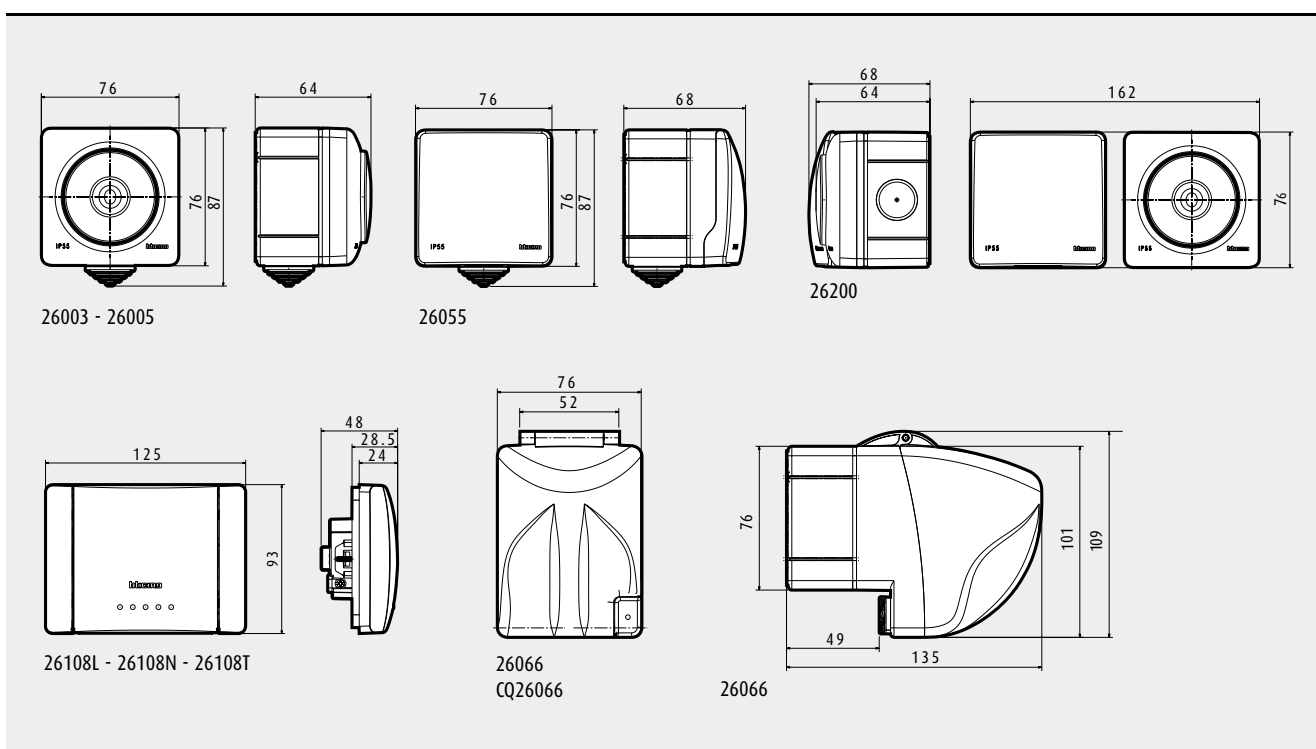



BTicino SpA
Via Messina, 38
20154 Milano - Italy
www.bticino.it